



Large Laundry Presses "VL" Series

Models A51/A53/A54/A4224

Models ATA51/ATA53/ATA54/ATA4224



Model A53VL • Safety Bar Activated



Model ATA53VL • Two Button Activated

- Fast head closing for maximum operator efficiency
- Most models available steam or electrically-heated
- Multiple buck sizes and configurations to choose from
- No electricity hook-up needed on steam-heated models
- Available in either bar or two button activated closing system
- Patented mechanism provides reliable service at minimal operating costs
- Options include Iron Tray Attachment, Water Spray and Air Timer

Forenta's large laundry presses have long been considered the industry standard for speed and efficiency. Available in both steam and electrically-heated models, these presses are offered in multiple buck sizes and with various options. This patented, time-tested design provides simplicity and reliability and is backed by one of the best warranties in the industry.

www.forentausa.com

Tel: 423-586-5370 • Email: info@forentausa.com

Made in USA

"VL" SERIES SPECIFICATIONS

Steam connections:

- 1/2 NPT for supply and condensate
- 100-125 psi (0.69-0.86 MPa)
- Steam consumption at 100 psi(0.69 MPa):
- 1 BHP(34.4 lb/hr)(15.6 kg/hr)

Compressed air connection:

- 3/8 NPT
- Recommended Air Pressure: 68 psi (0.47 MPa)
- Free air/cycle at 68 psi (0.47 MPa): 0.31 cubic feet (8.8 liters)

Electrical connection: (A51VLE & ATA51VLE)

- 230 VAC single-phase, 50/60 Hz, 4800watts
- Approx. Consumption/Hour 2.4 KWH

Electrical connection: (A53VLE & ATA53VLE)

- 230 VAC single-phase, 50/60 Hz, 7400watts
- Approx. Consumption/Hour 3.75 KWH

Electrical connection: (A54VLE & ATA54VLE)

- 230 VAC single-phase, 50/60 Hz, 5350watts
- Approx. Consumption/Hour 2.75 KWH

Optional hand iron electrical connection (external wiring, not part of press internal wiring):

- 115 VAC or 230 VAC single-phase, 50/60 Hz
- Conduit connection
- 800 watts
- Approximate hourly consumption: 0.5 KWH

Optional water spray cold water connection:

- 1/4 NPT
- 40-80 psi (0.3-0.55 MPa)
- 1 gallon/minute (3.8 liter/minute)

Note: 4224 not available in electric

BUCK DIMENSIONS (unpadded)

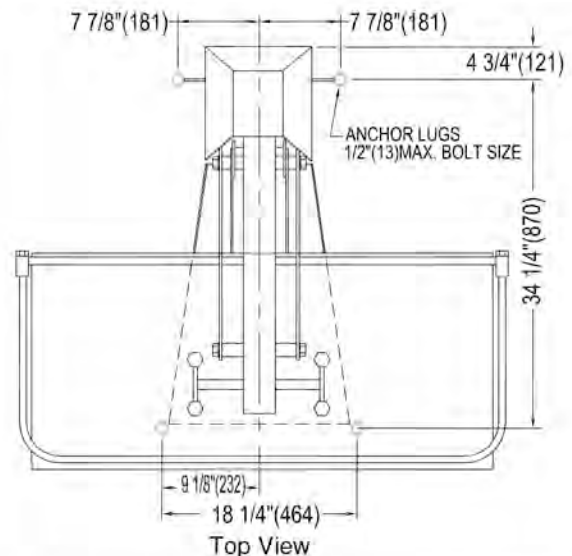
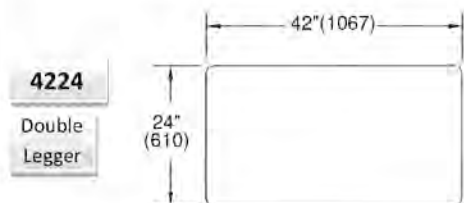
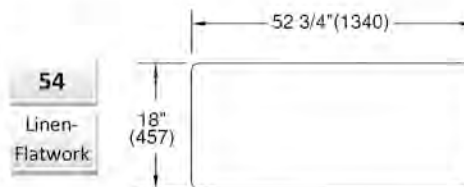
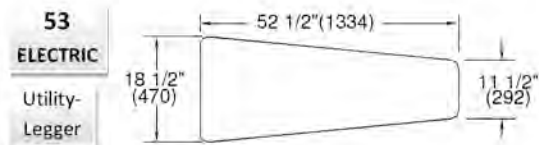
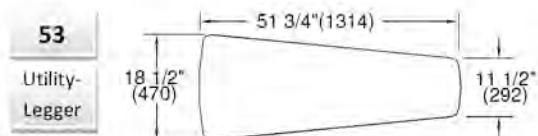
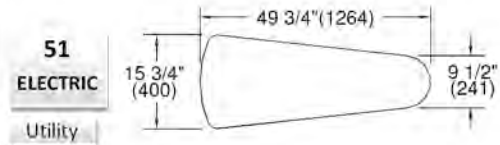
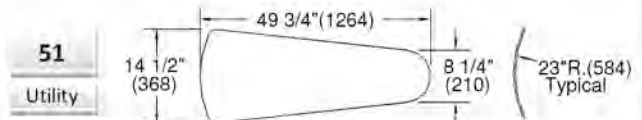

Optional Attachment Kits

K-213 Steam/Electric Iron Attachment, 115 Volt

K-464 Steam/Electric Iron Attachment, 230 Volt

K-214 All-Steam Iron Attachment

K-210 Water Spray

K-228 Timer Kit for "A" models

K-594 Timer Kit for "ATA" models